

MANUFACTURED FOR:
MITSUBISHI ELECTRIC US, INC.

LAHN-1/ LAHN-3 Low Ambient Hoods

For use with:
CITY MULTI[®] N-Generation Air Cooled Outdoor Units

TECHNICAL & SERVICE MANUAL

FOR INSTALLER

For safe and effective use of these items, please read this manual thoroughly before installing these components.

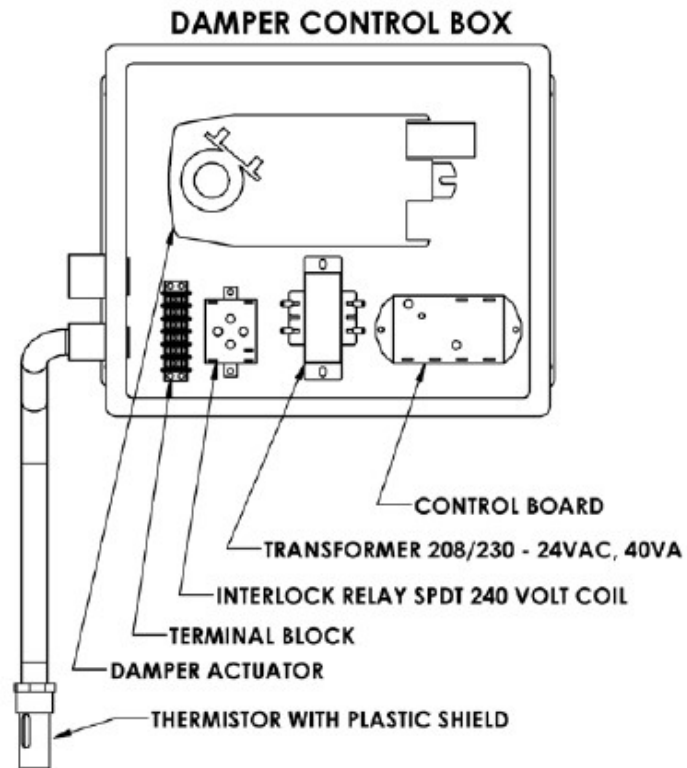

Table of Contents

1. Control box component identification	5
2. Operating sequence	6
3. Damper blade adjustment	12
4. Additional louver adjustment: EXL ODUs ONLY	16
5. Damper actuator manual override	18
6. Parts list	21
7. Wiring diagram	23



1. Control box component identification



2. Operating sequence

Outdoor unit in cooling mode

The LAHN-1/LAHN-3 low ambient hood is designed to reduce the airflow through the outdoor units as the ambient temperature drops. This maintains the head pressure at a level that will allow the system to perform at full capacity down to -10°F outdoor temperature.



NOTE

For R2 Systems: *Full cooling capacity down to -10°F. **In cooling mode or cooling main, to guarantee full cooling capacity, the system must operate with a constant heat load in the zones requiring cooling when ambient temperatures fall below 5°F.

A thermistor mounted on the side of the unit senses the outdoor temperature. As the outdoor temperature drops, the resistance of the thermistor increases. The thermistor is connected to the specially designed circuit board and the resistance value from the thermistor is converted to a DC voltage output within the circuit board. This DC voltage output drives the damper actuator to a predetermined position based on the outdoor temperature. The inverter-driven fan motor will adjust the discharge pressure based on system capacity demand. The motor will speed up and force more air through the damper if there is a higher system capacity demand, or slow down if system capacity demand decreases.

Outdoor unit in heating mode

Heating mode requires the damper to be in a fully open position to allow full airflow and maximum heating capacity. Heating mode automatically deactivates the kit through an interlock relay. The coil for this relay is tied into the reversing valve connection on the outdoor unit. When the unit switches to heating mode, the reversing valve is energized. This in turn energizes the interlock relay. When the relay is energized, the normally closed contact opens. By opening this contact, the power to the transformer and control board is interrupted, this allows the damper to spring to the fully open position.

Outdoor unit in defrost mode

If the outdoor unit will be running in heating mode, a defrost period is inevitable. During defrost, the low ambient controls see this as the unit operating in cooling mode. If the outdoor temperature is below 40°F, the damper will close to a position equal to that required during the cooling cycle. Once the unit comes back out of defrosting and into heating mode, the damper will again spring wide open for full airflow.

Operation test

Outdoor unit must be in cooling mode.

All hoods and damper controls are tested at the factory before shipping. To perform an operational test once the installation is complete, follow the steps below. Please refer to the following chart and table for detailed control logic.

Operation testing when the outdoor ambient is ABOVE 40° F

1. Turn on power to the outdoor unit.
2. Make sure the outdoor unit is in cooling mode.
3. Locate the outdoor temperature sensing thermistor at the end of the short conduit coming out the side of the control panel. The thermistor can be seen inside the plastic shield.
4. Using an aerosol dusting sprayer, invert the can and spray the thermistor with very short bursts of the cold liquid. Do not over spray the thermistor as it could be damaged. It may take 10 – 20 seconds for the internal thermistor temperature to drop. The damper will start to move toward the closed position after the thermistor drops below 35° F.
5. Once the thermistor warms above 40° F, it will move back to the fully open position indicating the low ambient kit is working as designed.

Operation testing when the outdoor ambient is BELOW 35° F

1. Turn on power to the outdoor unit.
2. Make sure the outdoor unit is in cooling mode.
3. The damper will move toward the closed position to a predetermined angle based on the outdoor ambient temperature indicating the low ambient kit is working as designed.
4. Once the thermistor warms above 40° F, it will move back to the full open position indicating the low ambient kit is working as designed.



IMPORTANT

If either of the tests above fails, please check all electrical connections according to the previous installation instructions and test again. If the unit still does not test correctly, contact your Mitsubishi distributor.

Ambient temp [°F]	Hood angle [°]	Output Voltage [VDC]	Resistance [Ω]
-10	80	8.7	117960
-5	80	8.7	100184
0	75	7.8	85340
5	75	7.8	72906
10	75	7.8	62460
15	75	7.8	53658
20	70	7.0	46220
25	70	7.0	39917
30	70	7.0	34562
35	70	7.0	30000
40	OPEN	2.0	26104
45	OPEN	2.0	22767

LAHN Damper Hysteresis Control

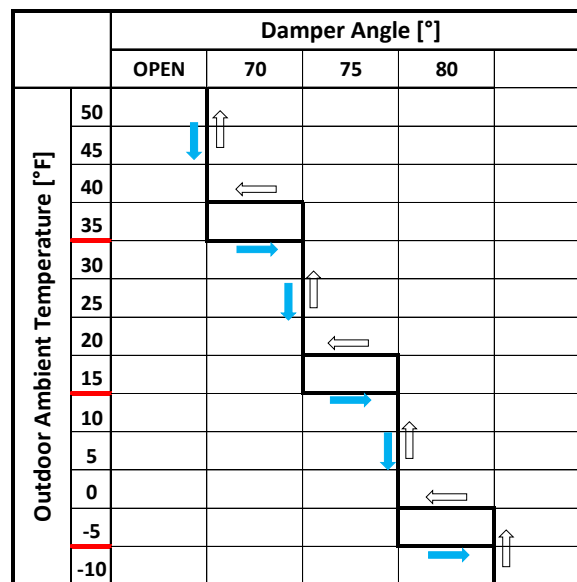

↑ = As Temperature Increase
 ↓ = As Temperature Decrease

Component troubleshooting Thermistor

The thermistor is a 10,000 Ω, NTC Type. The circuit board has a blinking indicator light built in to reference what the thermistor is sensing. The following chart shows what the blinking light sequence means.

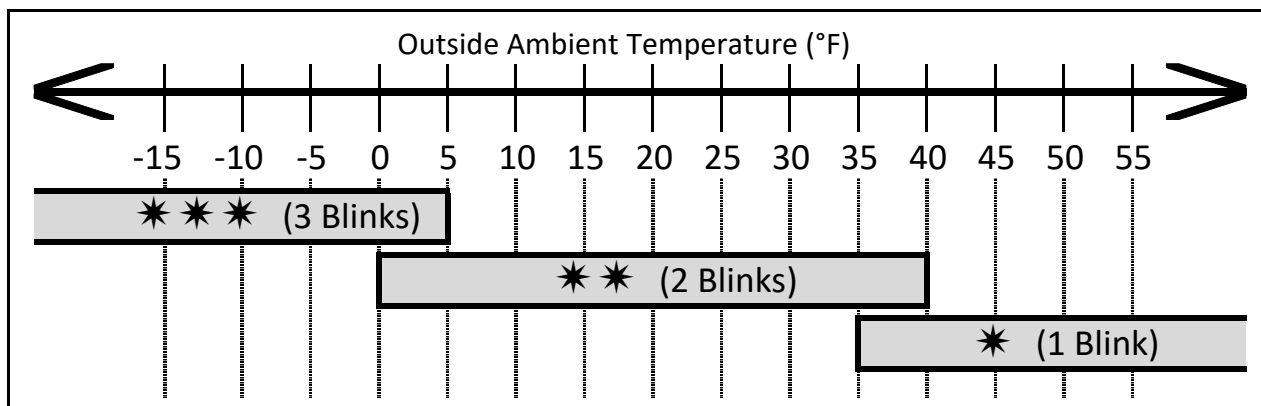

If the light is on constantly, the thermistor is open or shorted and needs to be replaced. If the blinking light sequence doesn't fall within the range given in the chart, the thermistor needs to be replaced. If it's suspected that the thermistor is operating inaccurately, check the tolerance in the following instructions. Disconnect the thermistor from the control board. Measure the resistance across the two leads. Measure the temperature of the thermistor. (Accuracy on the temperature reading is important to prevent a good thermistor from being replaced). Compare the ohm reading with the temperature on the chart below. Based on the thermistor temperature the ohm reading should be within 3% of the number shown below. If not, and the thermistor connections are not corroded, the thermistor should be replaced.

°F	Ohms	°F	Ohms	°F	Ohms	°F	Ohms
86	8,056	59	15,714	32	32,650	5	72,906
84	8,448	57	16,551	30	34,562	3	77,620
82	8,682	55	17,438	28	36,601	1	82,676
81	9,077	54	17,902	27	37,671	0	85,340
79	9,526	52	18,873	26	38,776	-2	90,962
77	10,000	50	19,903	23	42,315	-4	96,999
75	10,501	48	20,997	21	44,875	-6	103,486
73	11,301	46	22,159	19	47,610	-8	110,460
72	11,307	45	22,767	18	49,047	-9	114,141
70	11,884	43	24,040	16	52,069	-11	121,921
68	12,493	41	25,394	14	55,301	-13	130,295
66	13,139	39	26,835	12	58,759	-15	139,313
64	13,822	37	28,368	10	62,460	-17	149,030
63	14,179	36	29,171	9	64,408	-18	154,169
61	14,924	34	30,856	7	68,510	-20	165,048

Circuit board

Confirm the thermistor is operating properly before troubleshooting the circuit board. Make sure the control board has 24 Volts AC when measured at the 24 VAC and the com terminals. If not, find the cause of voltage failure. The circuit board is designed to convert the thermistor ohm input to a 2 - 9.16 VDC output to control the position of the damper actuator. Above 2 VDC output, the actuator will start to move the damper toward the closed position. At 9.16 VDC, the actuator will have moved 85 degrees and the damper will

be approximately 95% closed. The damper should never be 100% closed. The chart below includes the various damper angles based on the different outdoor temperatures. Measure the DC voltage output on the circuit board at com (-) and the out (+) terminals. If the output doesn't match the thermistor input ohms as shown below, replace the circuit board.

Ambient temp [°F]	Hood angle [°]	Output voltage [VDC]	Resistance [Ω]
-10	80	8.7	117960
-5	80	8.7	100184
0	75	7.8	85340
5	75	7.8	72906
10	75	7.8	62460
15	75	7.8	53658
20	70	7.0	46220
25	70	7.0	39917
30	70	7.0	34562
35	70	7.0	30000
40	OPEN	2.0	26104
45	OPEN	2.0	22767

Transformer

The transformer is 208 / 230 -24 volt AC. For proper connections to the outdoor unit, refer to the following diagram and instructions.

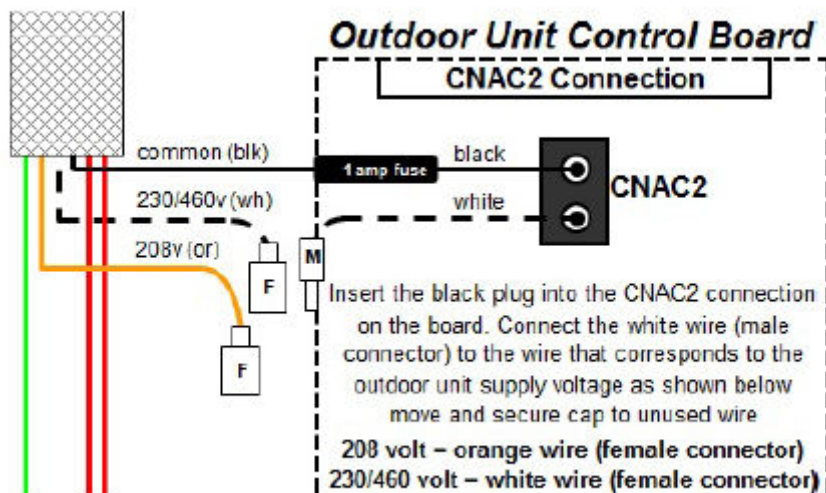

208 / 230 volt and also 460-volt outdoor units. On 208 volt units, the CNAC2 connector will provide 208 volts to the control transformer. On 230 volt units, the CNAC2 connector will provide 230 volts to the control transformer. The 460-volt units include a transformer that reduces the outdoor unit internal voltage to 230 volts. Because of this, on the 460-volt units, the CNAC2 connector will also provide 230 volts to the control

transformer. Once the proper connection is confirmed, measure the voltage on the primary side of the transformer. It should be 208 or 230 + / - 10% depending on the supply voltage at the outdoor unit. If there is no voltage on the primary side of the transformer check the fuse that is located in the fuse holder inside the outdoor unit. See wiring diagram for fuse location. Once power has been confirmed at the primary side of the transformer.

Interlock relay

The interlock relay uses a normally closed contact to allow power to flow to the transformer energizing the low ambient kit control circuitry. Any time the outdoor unit is in cooling mode, this contact will be closed. When the outdoor unit reversing valves energizes (switches to heating mode) the coil of the relay is energized, opening this contact. This in turn de-energizes the transformer, disconnecting power to the low ambient kit control circuitry. This allows the damper to spring return to the fully open position during heating mode. To check, make sure the contact is closed when the outdoor unit is in cooling mode (coil de-energized) and the contact is open when the outdoor unit is in the heating mode (coil energized).

Damper actuator Before troubleshooting the damper motor, verify the two factory switches are in the position shown below.

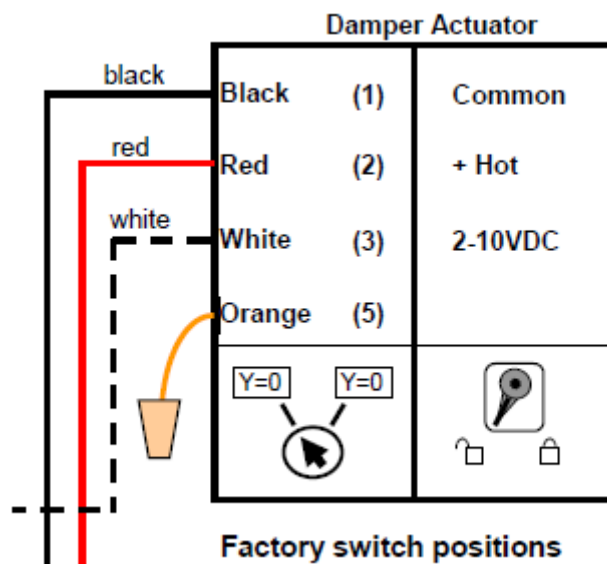

Make sure the motor has 24 volts on the (1) **Common** and (2) **+Hot** connections. If not, find the cause of the voltage failure and correct it. The damper actuator receives a DC voltage signal from the circuit board. This voltage can be measured between (1) **Common** and (3) **2-10VDC** connections. The damper actuator has an angle indicator where it clamps onto the damper shaft linkage. Compare the DC voltage supply to the damper angle indicator position in the chart below. The angle should be within 2% of the chart shown below. If not, check to make sure the damper started off in the correct position, **0 Degrees**.



IMPORTANT

It's possible that during shipping, the damper shaft may have moved in the actuator shaft clamp assembly. See Section 3. Damper Blade Adjustment.

LAHN-1/ LAHN-3 Low Ambient Hoods

If the damper actuator angle doesn't match within 2%, with the corresponding control board voltage supplied as shown below, the damper actuator should be replaced.

Ambient temp [°F]	Hood angle [°]	Output voltage [VDC]	Resistance [Ω]
-10	80	8.7	117960
-5	80	8.7	100184
0	75	7.8	85340
5	75	7.8	72906
10	75	7.8	62460
15	75	7.8	53658
20	70	7.0	46220
25	70	7.0	39917
30	70	7.0	34562
35	70	7.0	30000
40	OPEN	2.0	26104
45	OPEN	2.0	22767

3. Damper blade adjustment



IMPORTANT

It is possible that during shipping, the damper shaft may have moved in the actuator shaft clamp assembly. In some cases, due to manufacturing tolerances, the LAHN blades could close 100%.

The damper should never be 100% closed during operation. When working properly, the damper will be approximately 90% closed at -5 F and below for S, L, and XL units. FOR EXL ODUs ONLY, an additional adjustment is required which limits closure to 65% at 15 F and below. This additional step **MUST BE** followed for proper unit operation.. The following procedure will allow proper adjustment.

The Belimo damper motor within the LAHN control box has a built-in mechanical stop to adjust the maximum angle of rotation. This must be adjusted to 85 degrees and the damper blade position verified or re-set to the proper position (1/4" open) to ensure the unit functions properly. After this "calibration" step, FOR EXL ODUs ONLY an additional step **MUST BE** followed in which the built in mechanical stop is adjusted to ~65 degrees.

Belimo motor angle indicating scale shown below

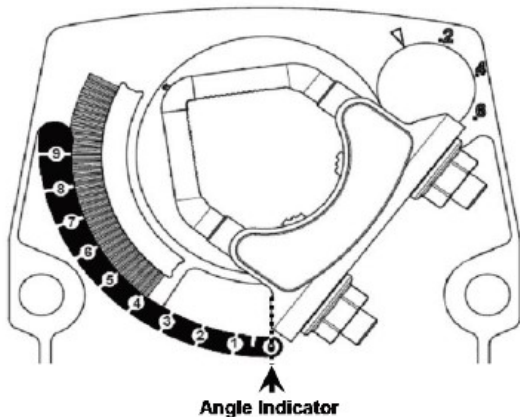

The factory setting for the mechanical stop is shown below at an 85-degree hood angle.



WARNING

ENSURE POWER IS OFF BEFORE STARTING!!

Basic Service Overview

1. Set damper motor stop to 85 degrees.
2. Loosen "U" bolts on the damper shaft.
3. Crank the motor against the 85-degree stop then lock it into position.
4. Set damper to approx. ¼" open. (Use damper crank handle as spacer.)
5. Re-tighten "U" bolts on the damper shaft.
6. Release motor by slightly cranking with handle. Check operation manually.
7. The goal is to have a ¼" opening on damper assembly in the 85-degree position.

Step 1. Loosen the Philips head screw for the mechanical stop.

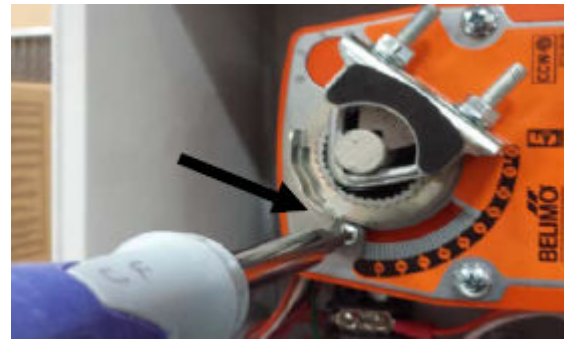

Step 2. Slide the mechanical stop to 85 (halfway between 8 and 9) and tighten the screw, making sure the locating teeth on the stop are engaged into the actuator motor teeth.

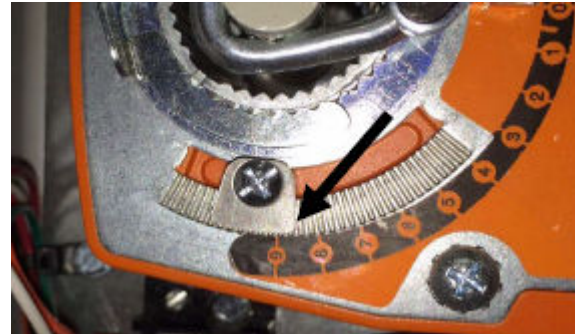

Step 3. Loosen the (2) nuts on the damper shaft "U" clamp.



Step 4. Using the crank handle turn the motor counterclockwise until the indicator snugs against the stop at 85 degrees.



Step 5. Lock the motor in the 85 degree position.

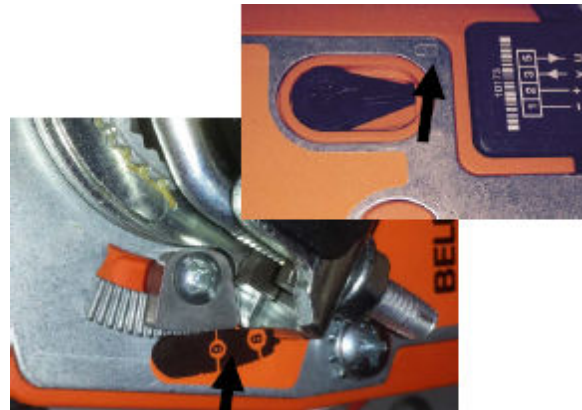

Step 6. Close the blades by hand and insert the crank handle under the damper blade near the screws as shown to ensure it is open approximately 1/4 inch at 85 degrees.



Step 7. Holding the blades against the handle re-tighten the (2) nuts on the damper shaft "U" clamp.



Step 8. Ensure that the end of the shaft is flush to the edge of the clamp black surface as shown.

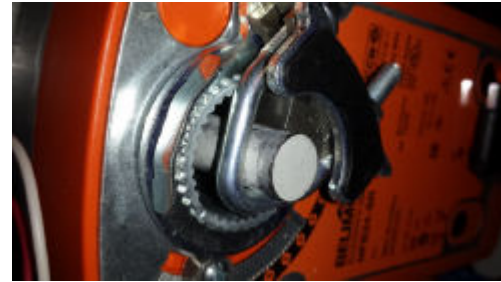

Step 9. Slightly crank the handle to release the motor. The damper will return to the open position.



Step 10. Review and Manual Test

To ensure the LAHN-1/LAHN-3 unit is functioning as designed, crank the Belimo motor back to the 85-degree position and visually check that the damper does not close completely. Your goal is approximately $\frac{1}{4}$ " opening between the blades at the 85-degree position.

4. Additional louver adjustment: EXL ODU's ONLY



IMPORTANT

This section is only to be followed for EXL ODU's. For clarification on which ODU's are EXL, refer to the Applications Guide.

The previous instructions must be followed to ensure the louver calibration is correct.

For EXL LAHX hood installation, the following steps **MUST** be taken to limit the maximum closure of the hood louvers and allow for intended ODU operation.

Step 1. Loosen the Phillips head screw for the mechanical stop.



Step 2. Slide the mechanical stop to approximately 65 degrees (between the "6" and "7" marks) and tighten the screw, making sure the locating teeth on the stop are engaged into the actuator motor teeth.

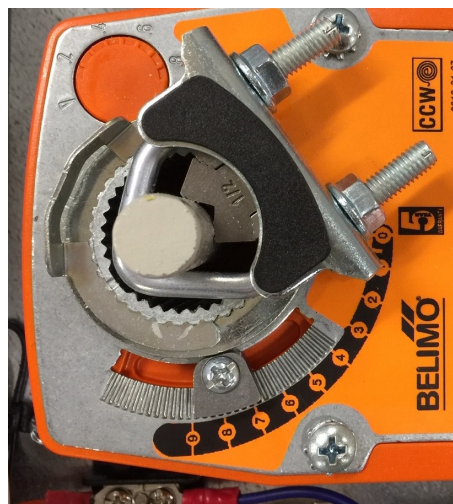

NOTE

The 65 degree position is likely the correct position for this mechanical stop, however this may need to be corrected.

- Final judgment of the correct mechanical stop position will be determined in step 4.

LAHN-1/ LAHN-3 Low Ambient Hoods

Step 3. Using the included crank handle, turn the motor counter-clockwise until the indicator stops against the mechanical stop. Lock the indicator against the mechanical stop using the locking switch, circled below.

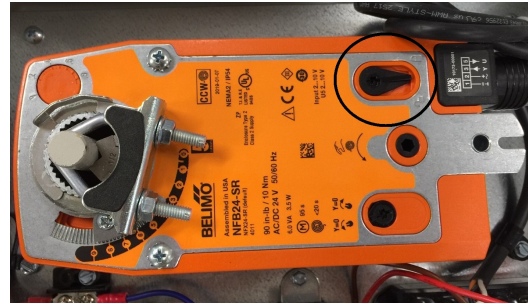

Step 4. Check the louver angle alignment in this position using a tape measure or other device. The gap between louvers should be 2.0". If the gap between louvers differs by more than 1/8", repeat steps 2 and 3 using a differing mechanical stop angle until acceptable louver spacing is achieved. See image below for measurement example.



Step 5. Once the louver spacing is adjusted properly, release the locking mechanism on the actuator. The louvers should return to their default open position.

5. Damper actuator manual override



WARNING

Never manually override the damper position if the outdoor unit could switch to heating mode during the override period. Heating mode requires the damper to be fully open for full capacity.



IMPORTANT

It may be desirable to manually override the damper position and lock it into position until repairs can be completed.

- If so, select an average temperature, typical for the outside environment during the override period, and then use that average temperature to find the desired damper angle (in the chart below).

Ambient temp [°F]	Hood angle [°]	Output voltage [VDC]	Resistance [Ω]
-10	80	8.7	117960
-5	80	8.7	100184
0	75	7.8	85340
5	75	7.8	72906
10	75	7.8	62460
15	75	7.8	53658
20	70	7.0	46220
25	70	7.0	39917
30	70	7.0	34562
35	70	7.0	30000
40	OPEN	2.0	26104
45	OPEN	2.0	22767

Follow the instructions below for manually positioning and locking the damper in place.



WARNING

Disconnect power to the damper motor before locking in place.



IMPORTANT

The damper actuator comes with a crank handle attached, to manually move the damper position.

The crank handle is removable and if it's missing, a 3/16" allen wrench will work just as well.

Use the following diagrams and instructions for this procedure.



Winding the damper actuator
-Insert Crank handle
-Turn the handle in the direction of the arrow.

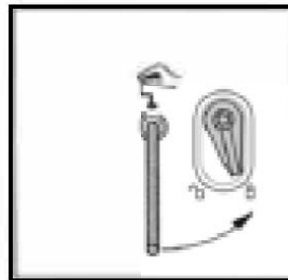

Locking the damper actuator
-Flip the lock switch to the position pointing to the "locked" symbol.

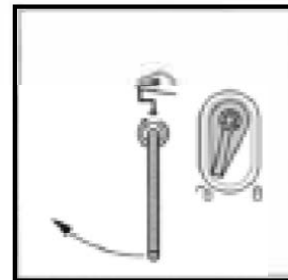

Unlocking the damper actuator
(2 options)
-Flip the lock switch to the position pointing to the "unlocked" symbol.
-Remote control by supplying power to the unit for > than 3 seconds

Use the following diagrams and instructions for this procedure.

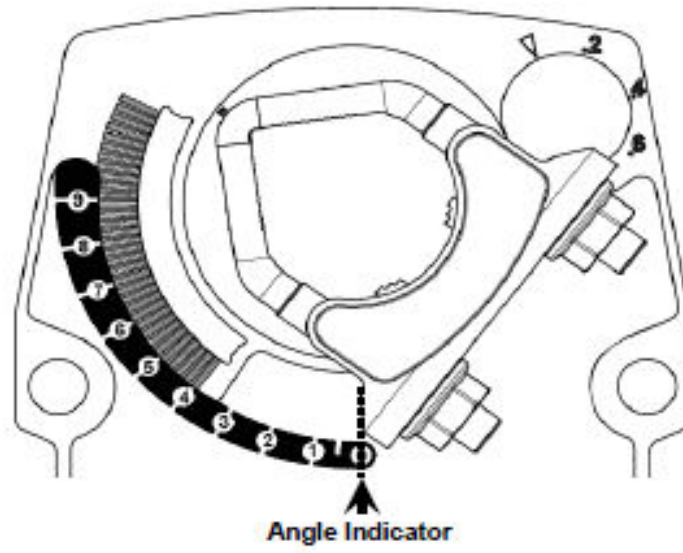

6. Parts list

Damper Control Box

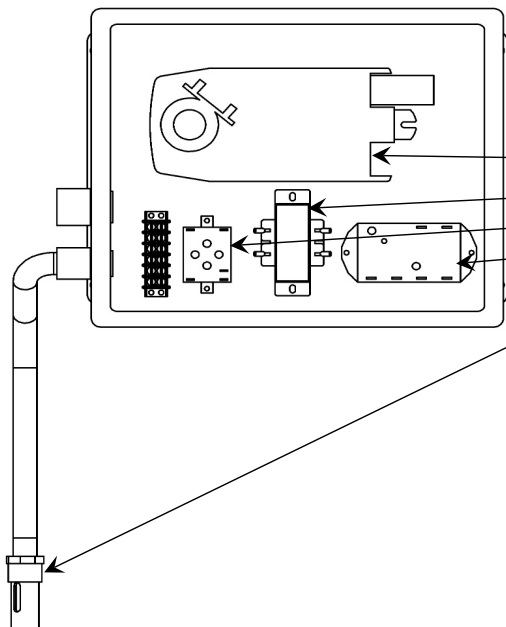

Part Description	Part Number
Damper Actuator	NFB24-SR
Transformer 208/230 - 24vac, 40VA	R68AA0005
Interlock Relay 240 volt coil	R68AB0006
Circuit Board	CB-LAHN-1 or DFC-M
Thermistor harness assy	TH-LAHK-1-A
CN505 Connector	HC-LAHK-1-1A
CNAC2 Connector	HC-LAHK-1-2A

Wire Harness Components

CN505 Connector
Part Number: HC-LAHK-1-1A
Includes everything shown

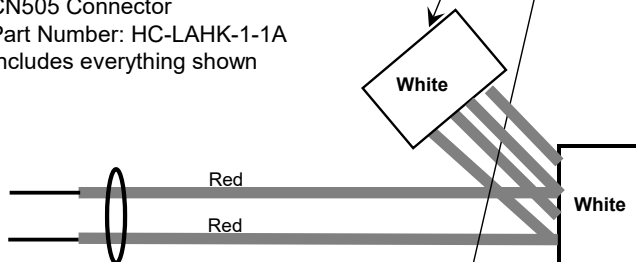

CNAC2 Connector
Part Number: HC-LAHK-1-2A
Includes everything shown

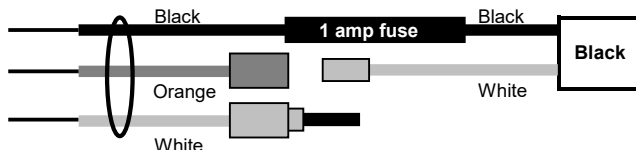



NOTE

Damper linkage parts can be purchased locally. If damper blades or complete assembly needs replacement, order new LAHN-2 / LAHN-4 hood and damper assembly.

7. Wiring diagram

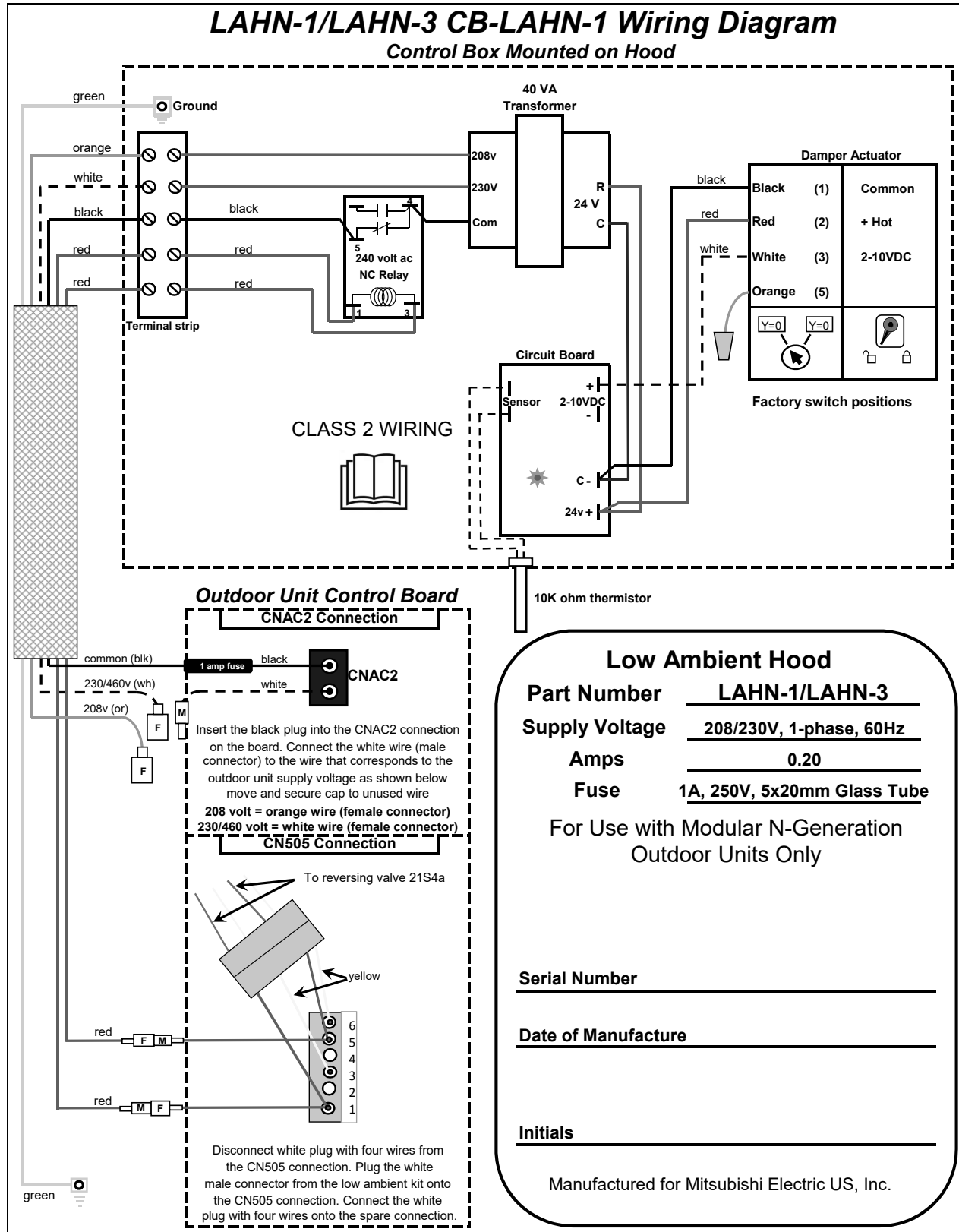







This product is designed and intended for use in the commercial and light-industrial environment.

Manufactured for:
mitsubishi electric us, inc.

www.mitsubishielectric-usa.com